

HEXAEDRE  
CUB  
PRISMA QUADRANGULAR

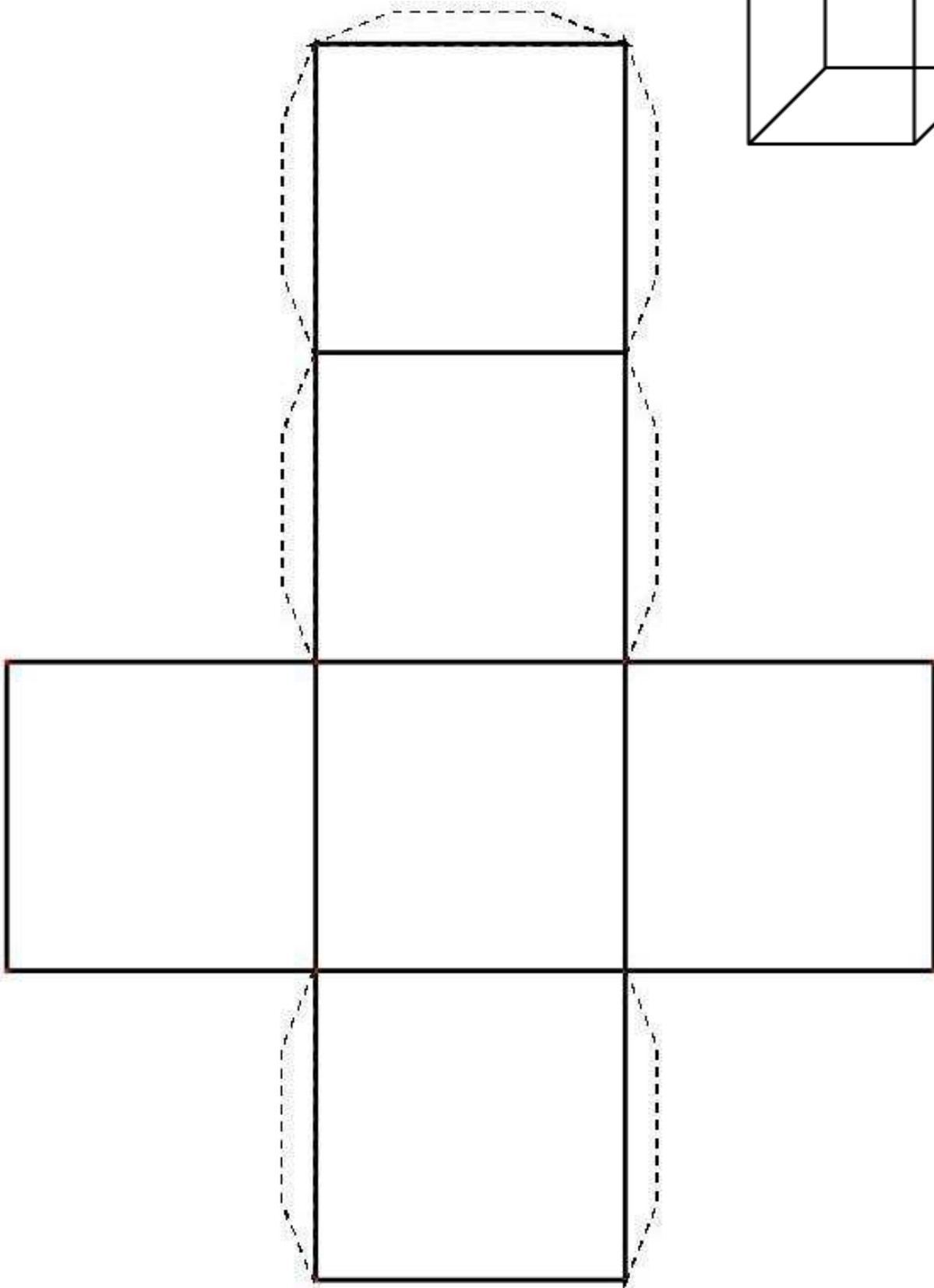

DODECAEDRE

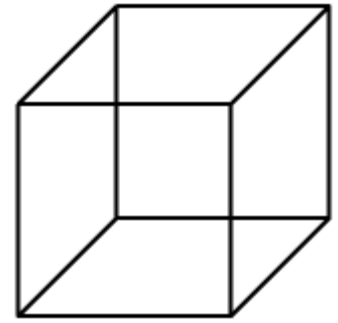
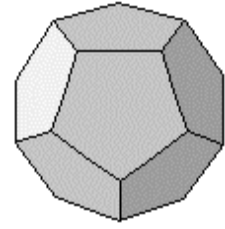
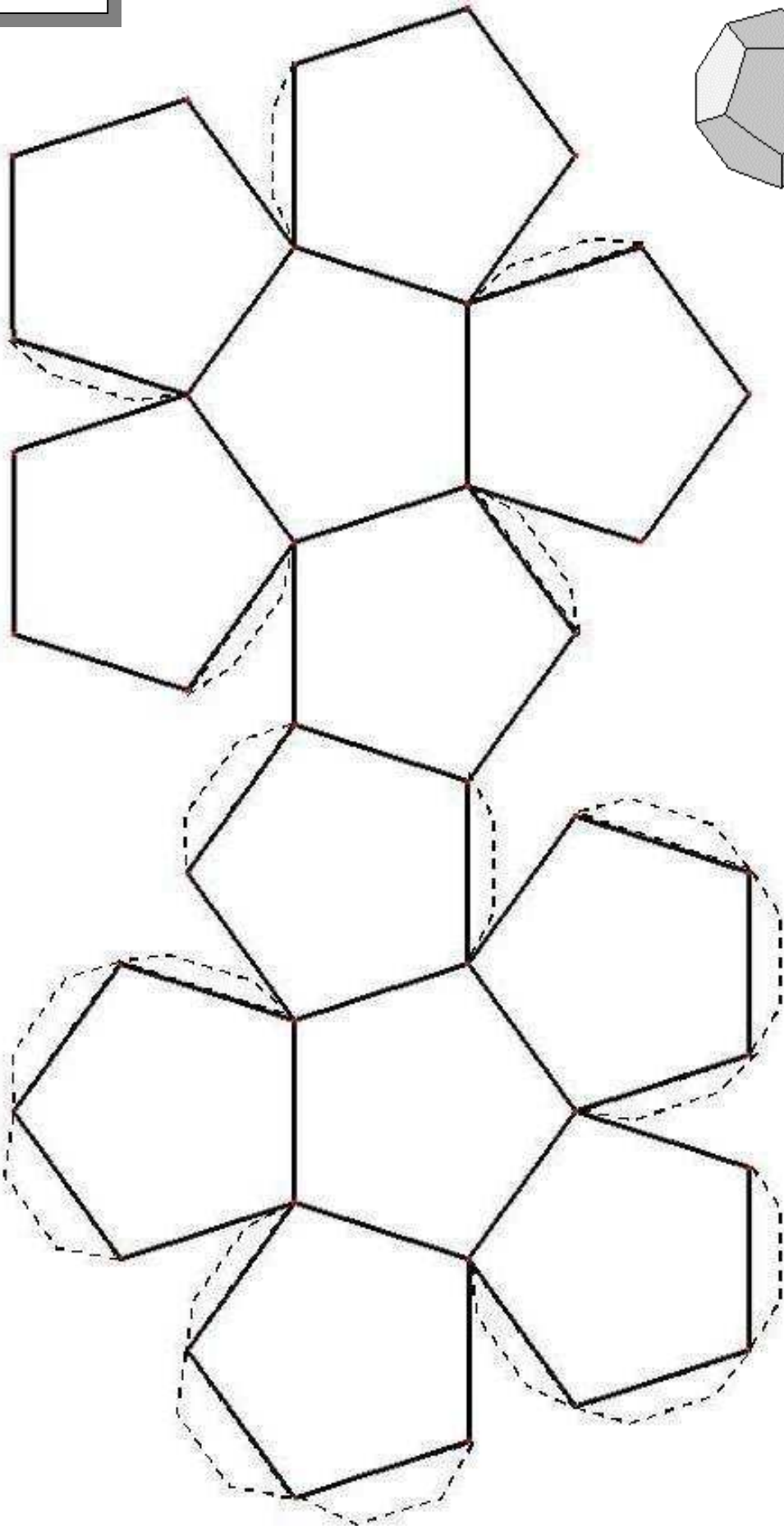

PRISMA HEXAGONAL

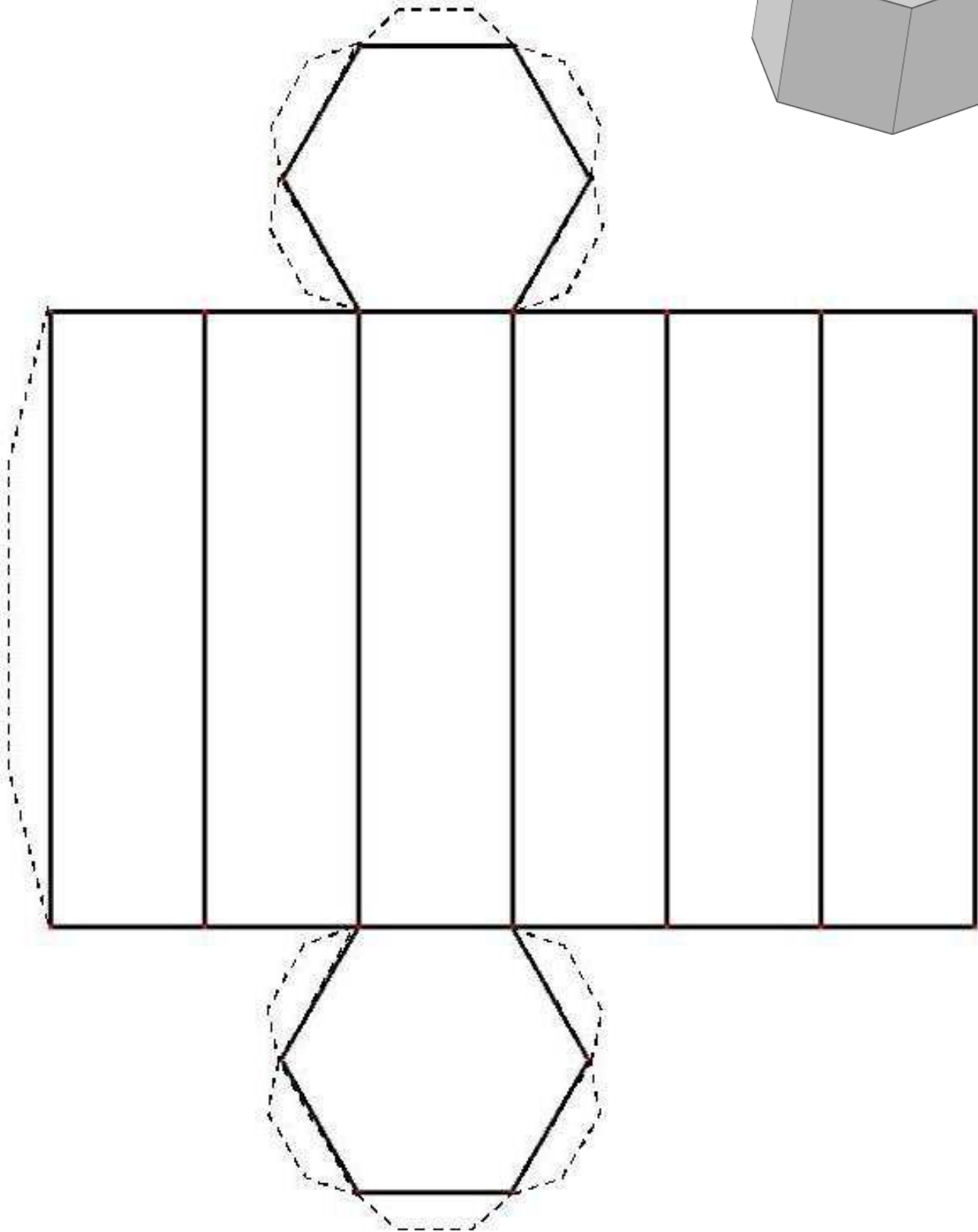
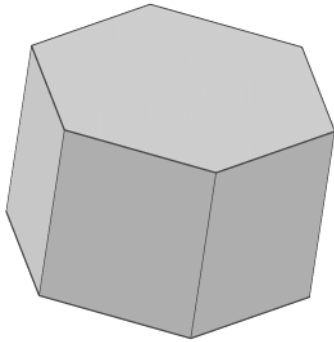

PIRÀMIDE HEXAGONAL

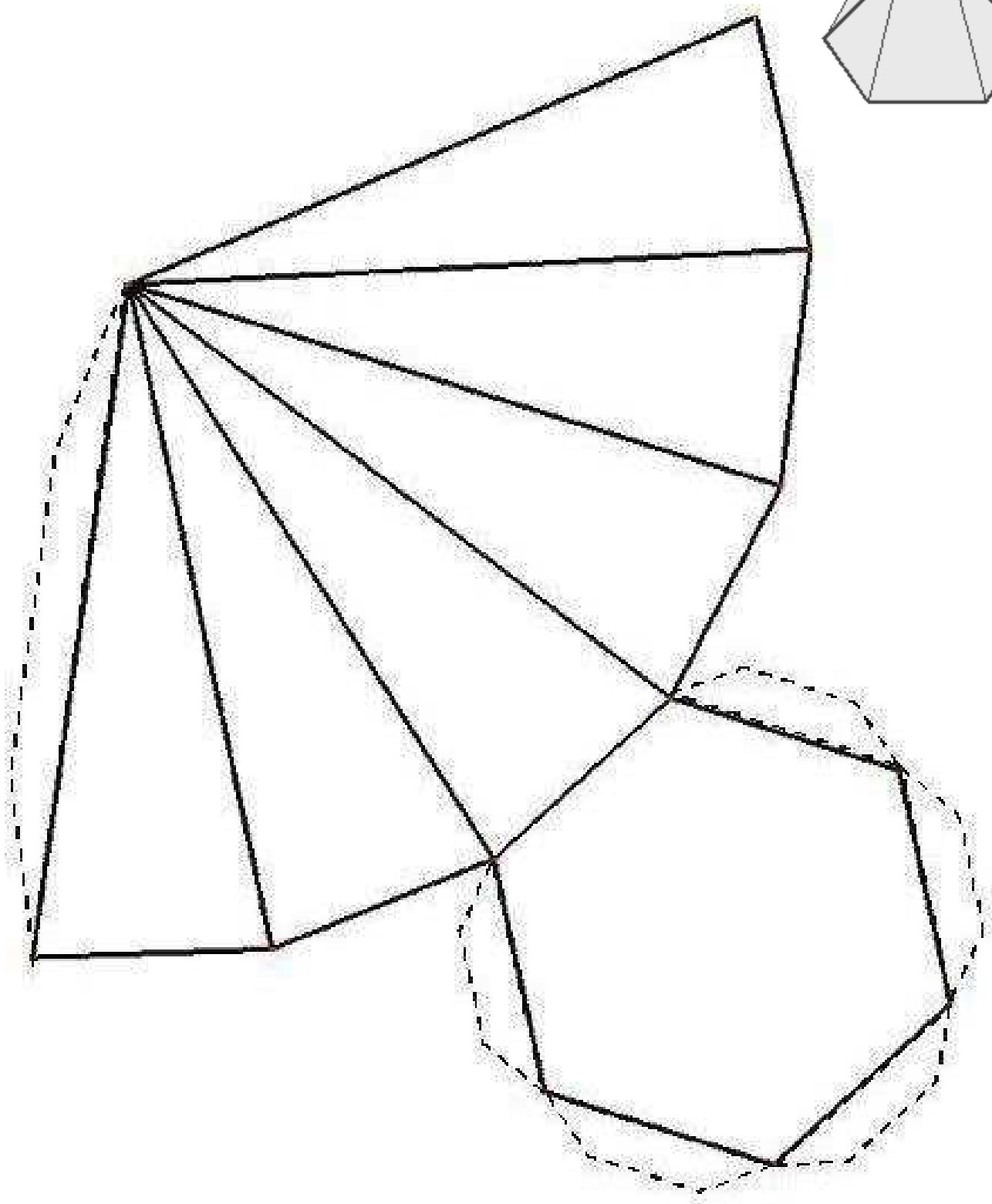
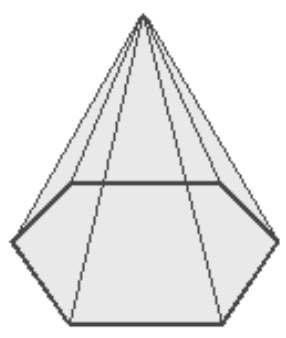

CILINDRE

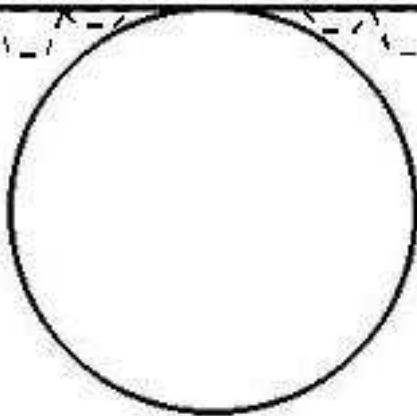
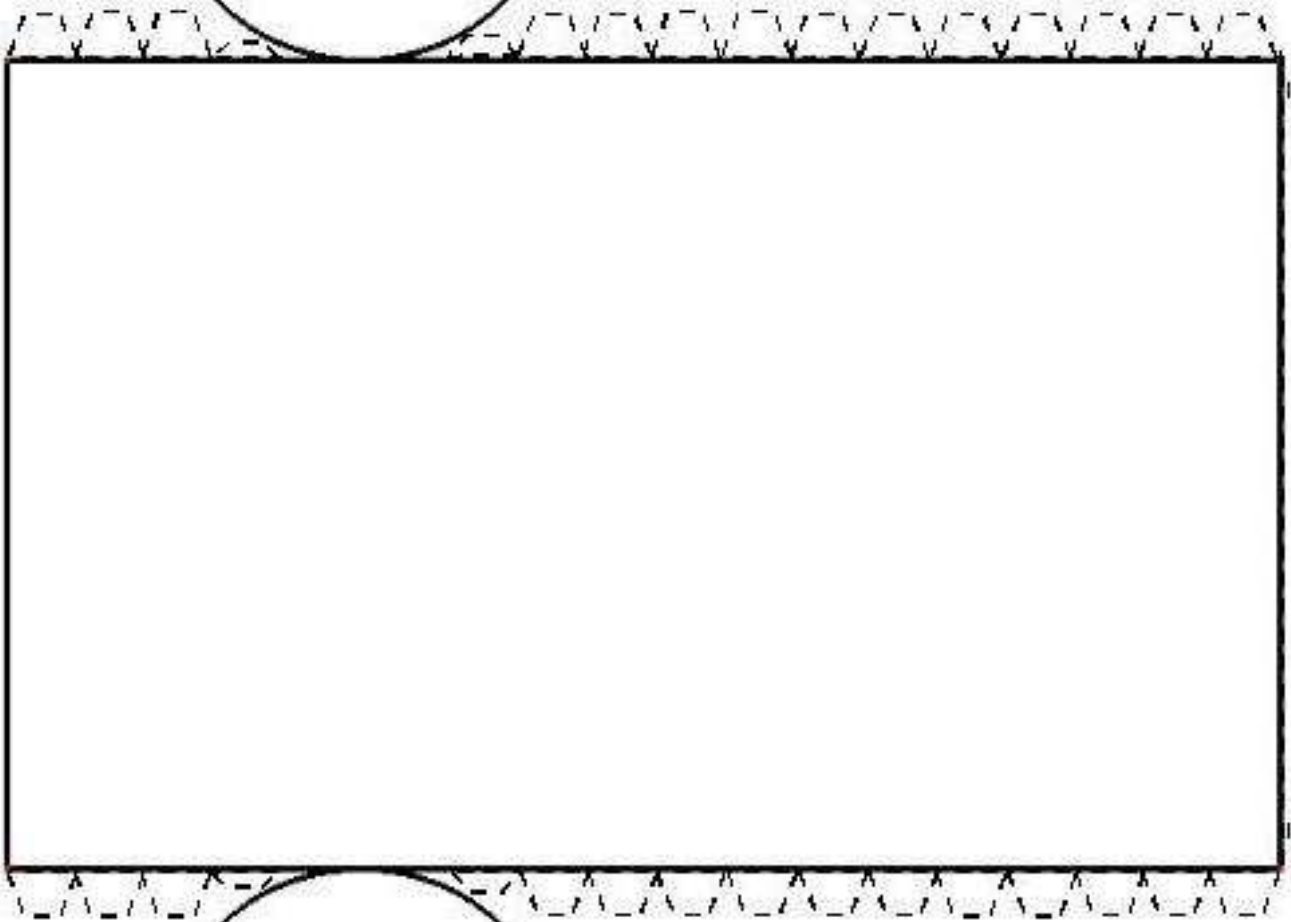
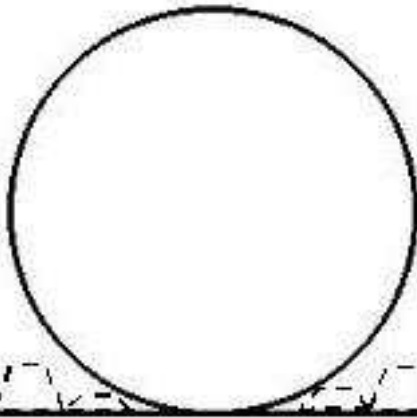

CON

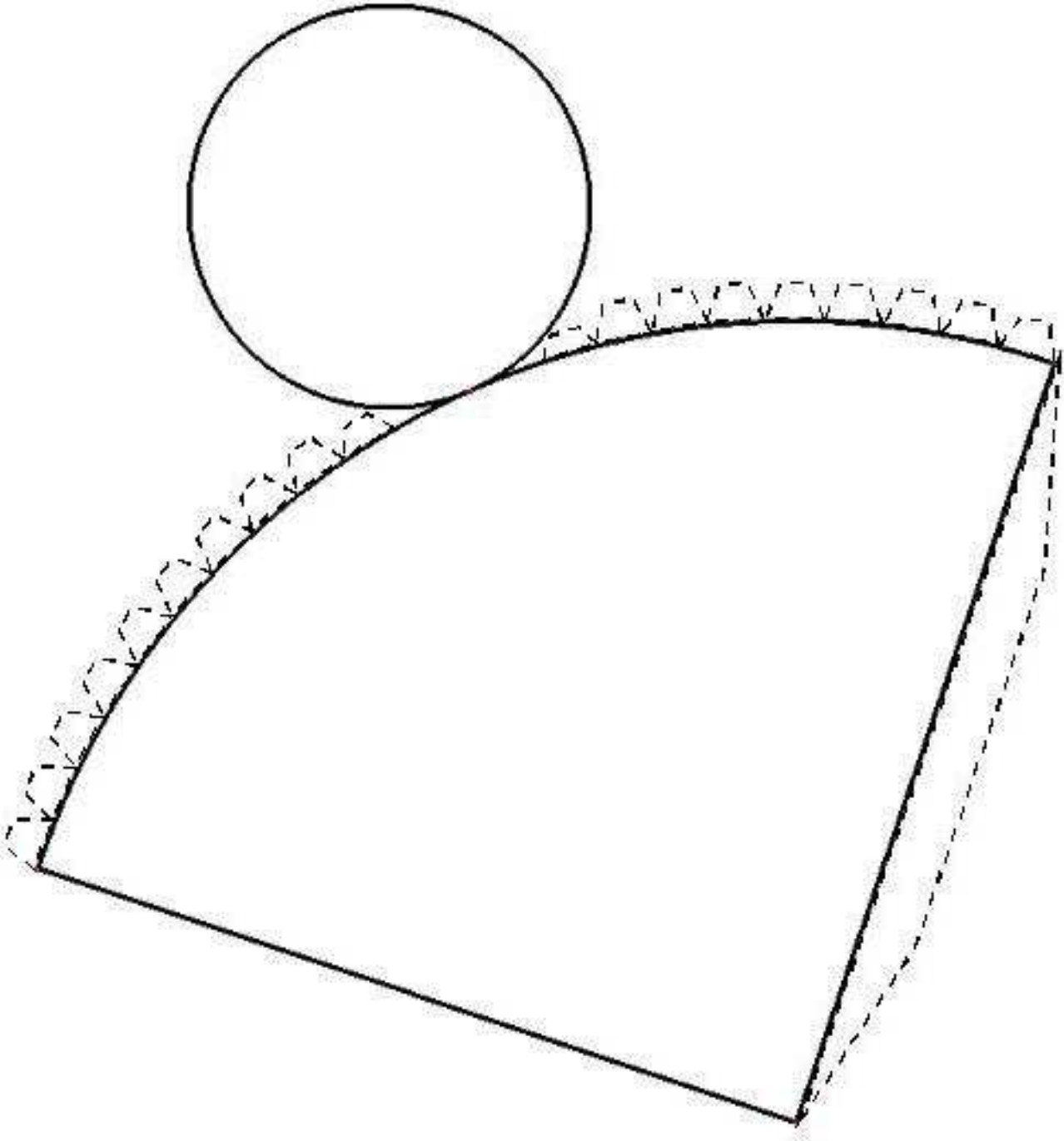
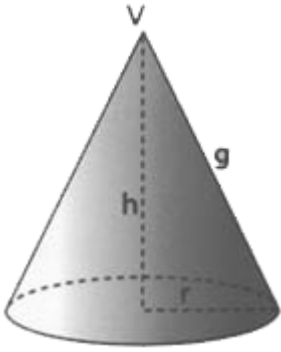

TETRAEDRE  
PIRÀMIDE TRIANGULAR

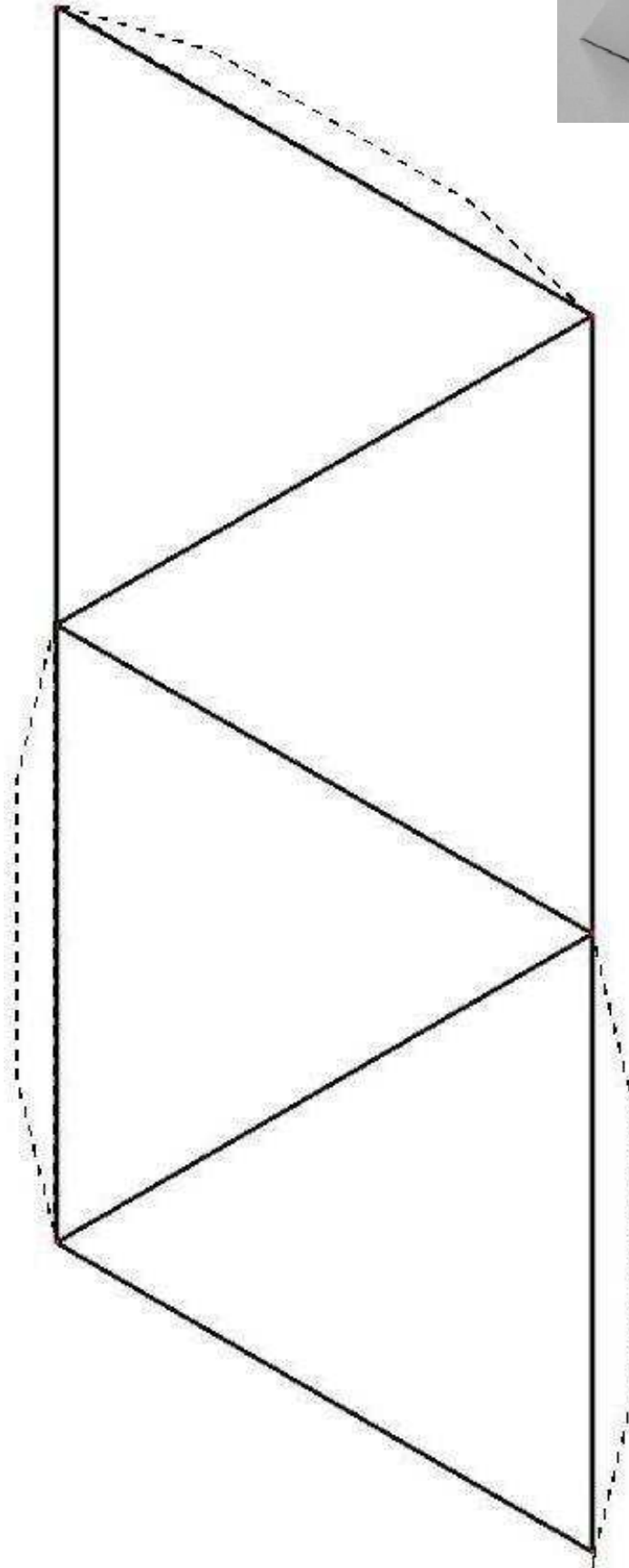
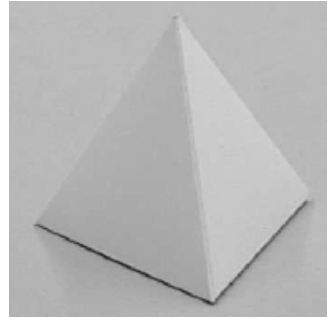

OCTAEDRE

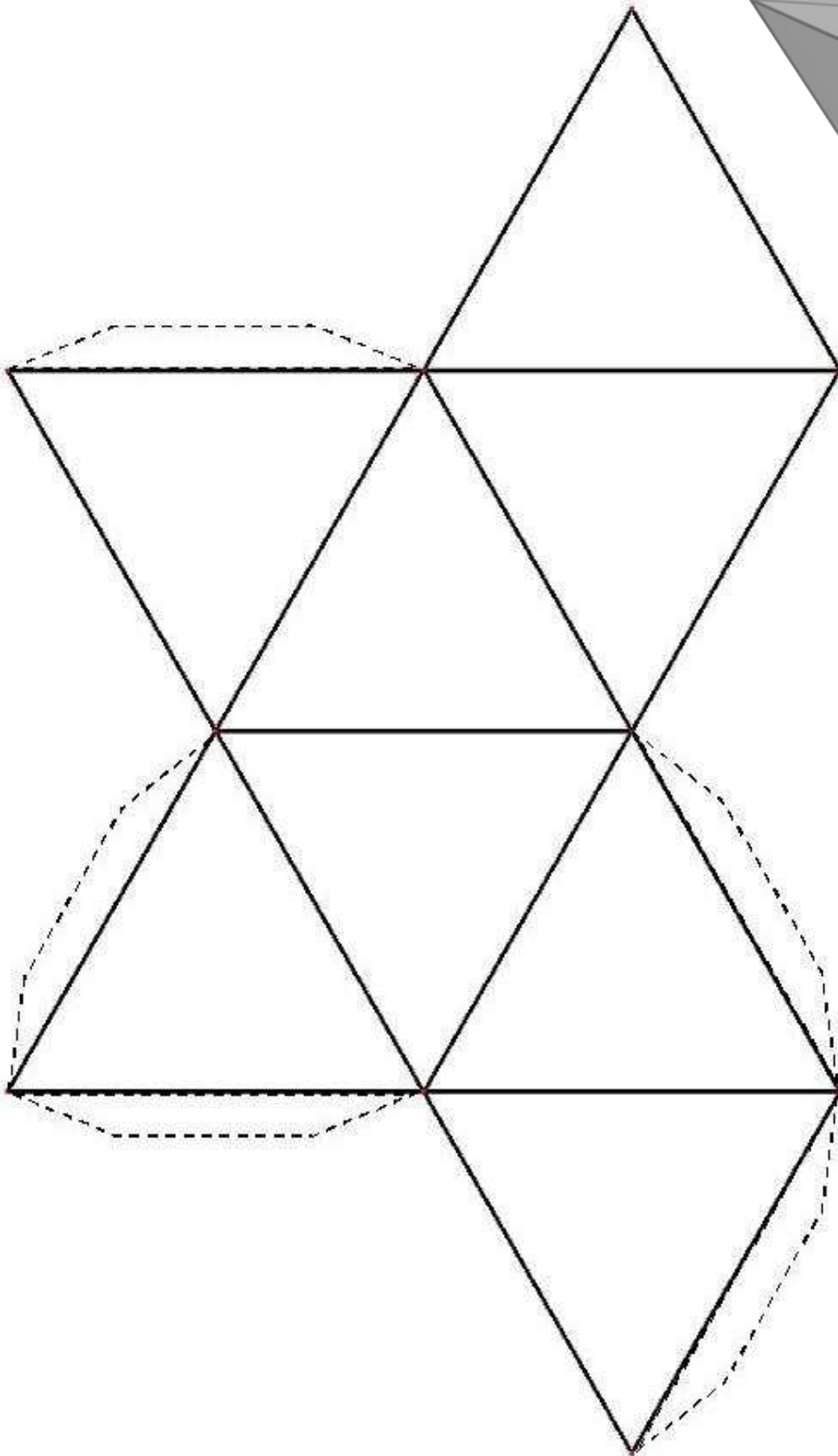
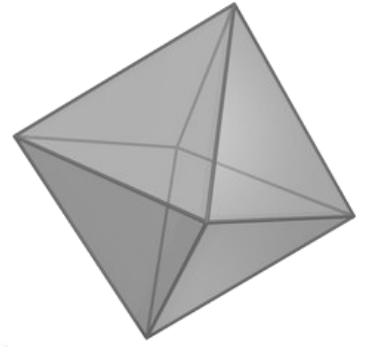

ICOSAEDRE

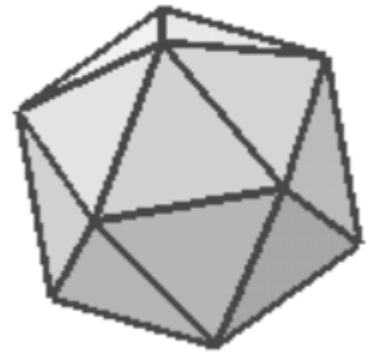
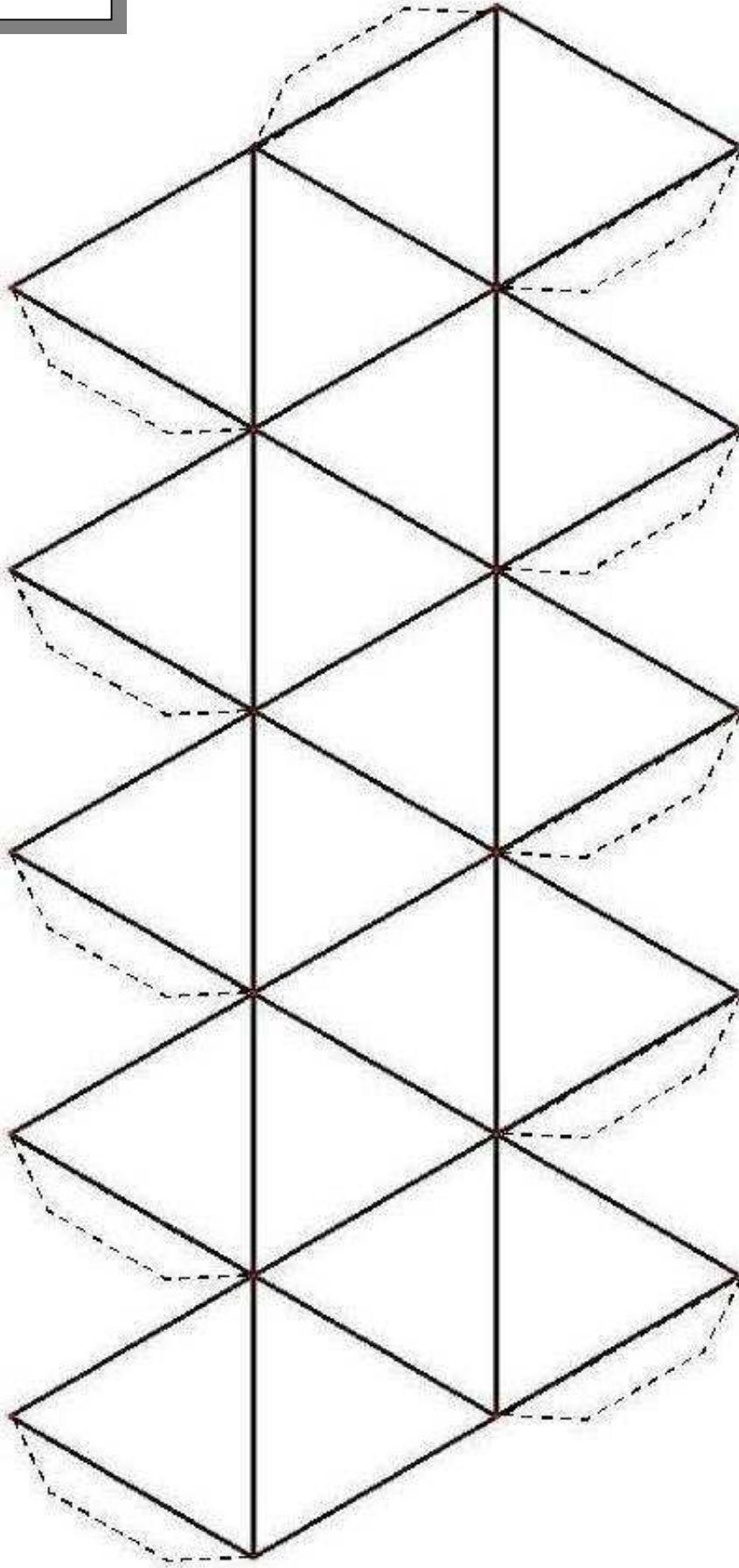

PRISMA QUADRANGULAR  
ORTOEDRE

